

NOTICE DE MONTAGE
Istruzioni per l'installazione
Assembly instruction

réf. AL 2020.02N
ref. AL 2020.02N
ref. AL 2020.02N

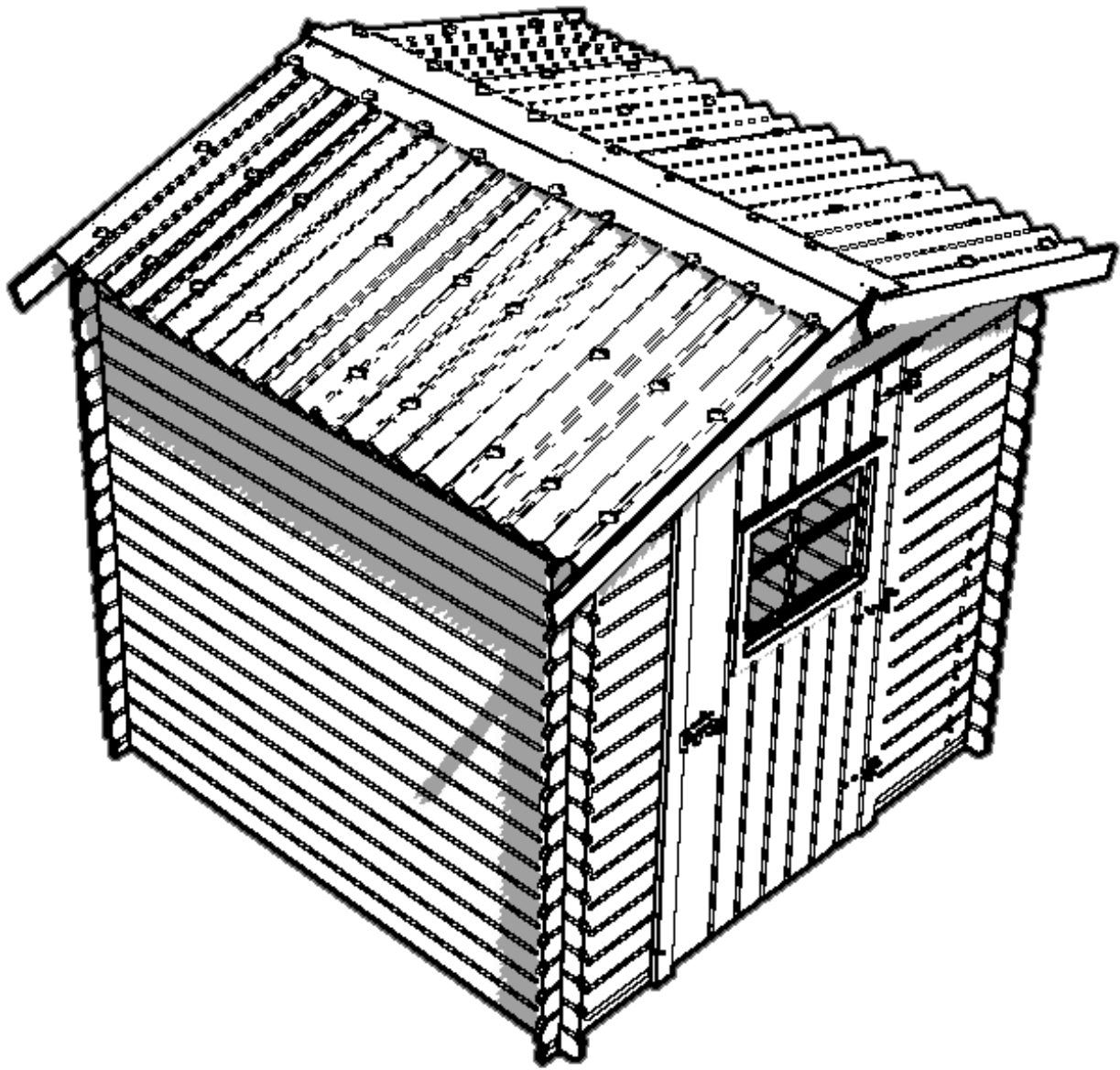

Surf. au sol / Superf. interna netta/ Internal surface : 3,8 m²

Surf. hors tout / Superficie totale/ Total surface : 4,08 m²

Pente de toit/ Pendenza tetto/ Roof slope : 17°

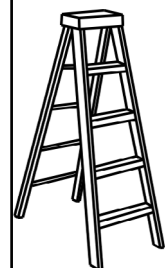

NOTICE DE MONTAGE
Istruzioni per l'installazione
Assembly instruction

réf. AL 2020.02N
ref. AL 2020.02N
ref. AL 2020.02N

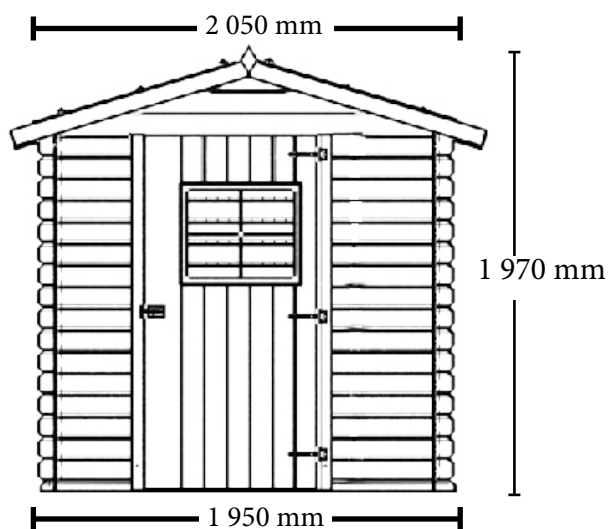

NOTICE DE MONTAGE
 Istruzioni per l'installazione
 Assembly instruction



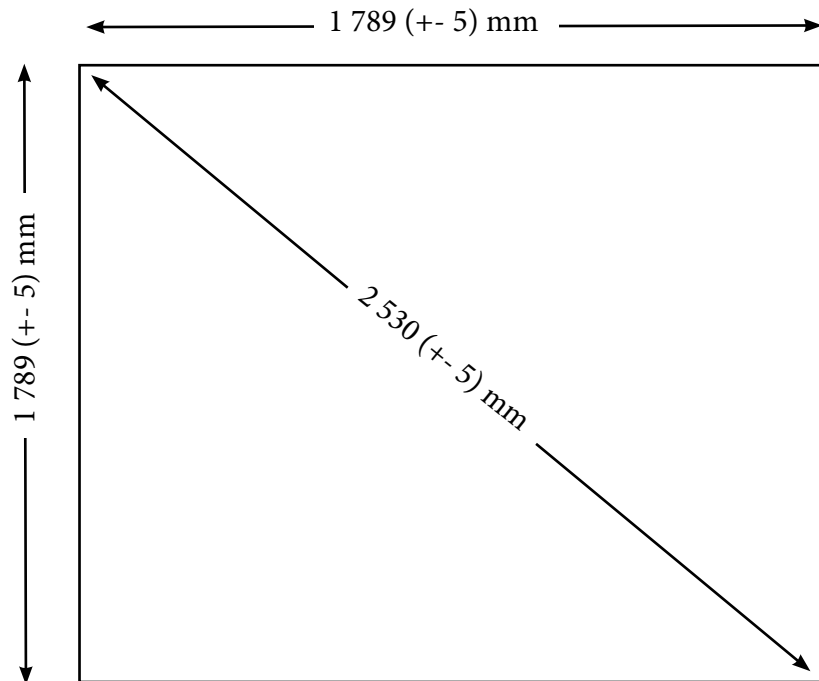





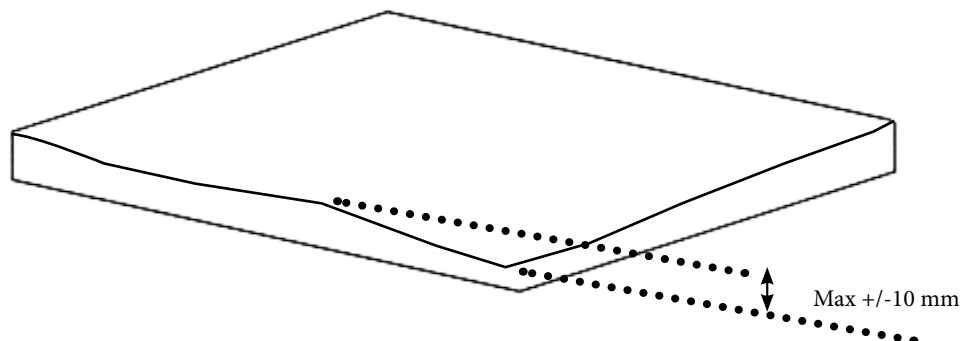



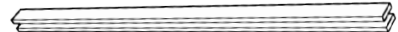
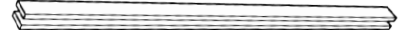

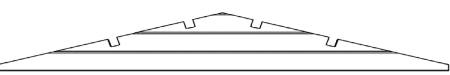

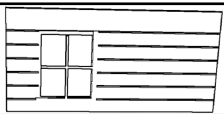
réf. **AL 2020.02N**
 ref. **AL 2020.02N**
 ref. **AL 2020.02N**

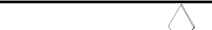







Les dimensions données sur le plan de soubassement sont les dimensions de la dalle béton à réaliser sur un sol parfaitement plat sans aucun autre objet extérieur type mur, clôture ou arbre dans l'entourage de la dalle. Si le produit est implanté près d'un mur, d'une haie ou d'un arbre il est nécessaire de l'éloigner des éléments extérieurs afin de pouvoir facilement le monter et l'entretenir. Nous nous dégageons de toute responsabilité en cas de mauvaise interprétation des dimensions de la dalle.

Le dimensioni del piano di base sono le dimensioni della soletta di cemento da realizzare su un terreno perfettamente piatto, senza alcun altro oggetto esterno, come un muro, una recinzione o un albero in prossimità della soletta. Se il prodotto è installato vicino ad una parete, un recinto o un albero, è necessario distanziarlo adeguatamente, in modo da poterlo facilmente montare e farne la manutenzione. Non ci assumiamo alcuna responsabilità per l'errata interpretazione delle dimensioni della lastra.



						Demande sav	
N°	REF	DES.	DIM (mm)	QTE	PLAN	OBS	QTE
1	I20.2.1950		1950x58x20	2			
2	L20.1.530		530x108x20	32			
3	L20.2.1950		1950x108x20	48			
4	TLS1690.20		1690x80x60	1			
5	TLD1690.20		1690x80x60	1			
6	ES 880.40		880X40X20	1			
7	ES200.70		200x70x20	2			
8	F20.1950.300		1950x300x40	2			
9	GL1950.70		1950x70x40	4			
10	UD1690.800		1690x800x40	1			
11	DSF1130.90		1130x90x20	4			
12	R150.90		150x80x20	2			
13	LSS20.2.1950		1950x108x40	1			
14	LSD20.2.1950		1950x108x40	1			
15	OND664.1000		664x1000x30	4			
16	OND498.1000		498x1000x30	4			
17	OND664.500		664 x500x30	2			
18	OND498.500		498x500x30	2			
19	FOND330.1000		1000x330x30	2			
20	FOND330.500		500x330x30	1			

Détail sachet de visserie

21	Vis 4 x 45			38			
22	Vis 3,5 x 35			20			
23	Clous L100			8			
24	Loq			1			
25	Clous L16			28			
26	Pentures			3			
27	Clous à tête moulée			60			

A compléter impérativement pour toute demande SAV et à envoyer par mail à sav@foresta.fr + photo des pièces abîmées (To be completed imperatively + Photo of damaged parts)

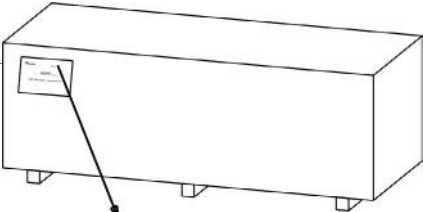
 <p>Colis n°: _____</p>	AL2020.02 N Colis(pac- kage) n° :	MAGASIN (STORE)	
		NOM (NAME) CLIENT	
		PRENOM(PRE.) CLIENT	
		N° de télé- phone(PHONE)	

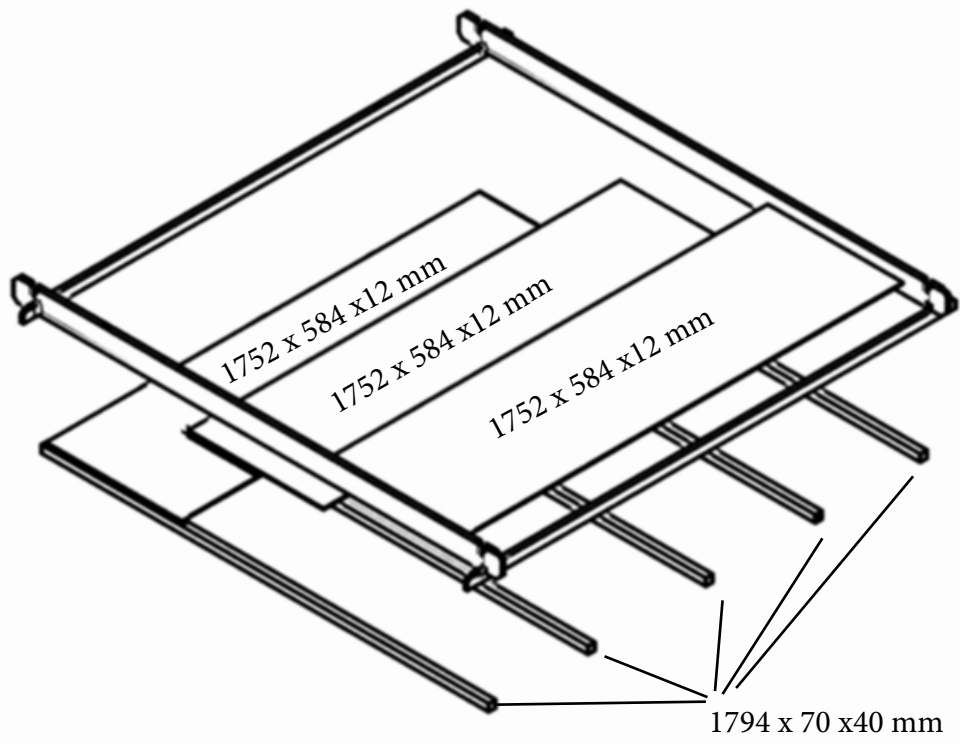

A

N1= 2 pcs.

N2= 2 pcs.

N3= 2 pcs.

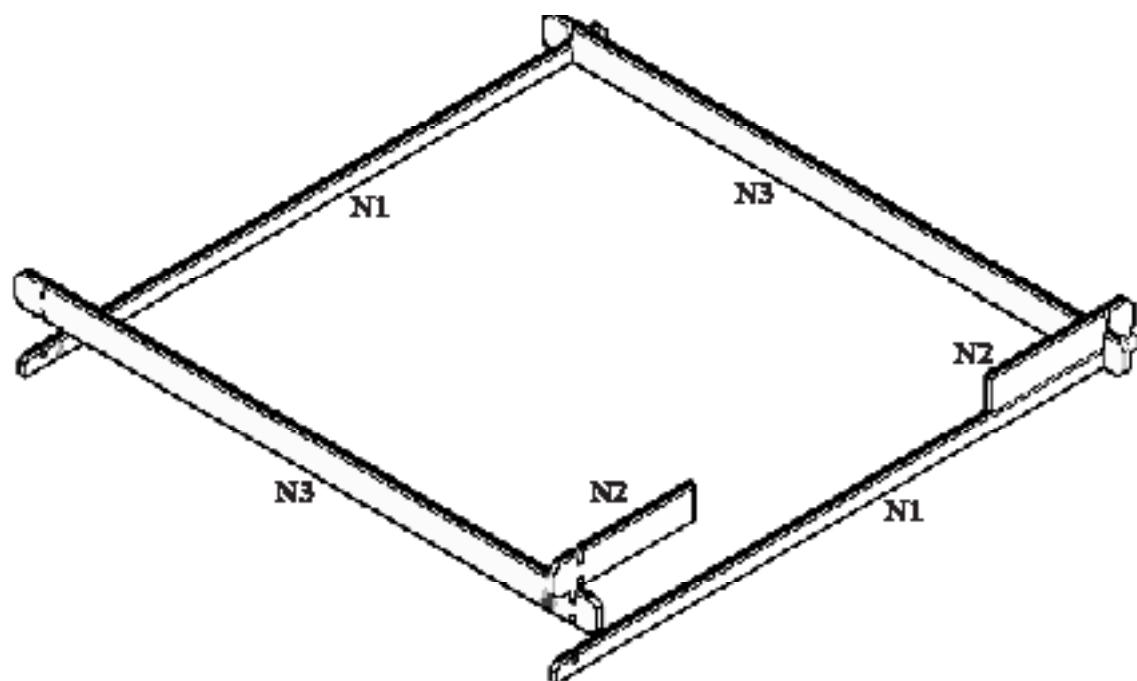

B

N3= 46 pcs.

N2= 30 pcs.

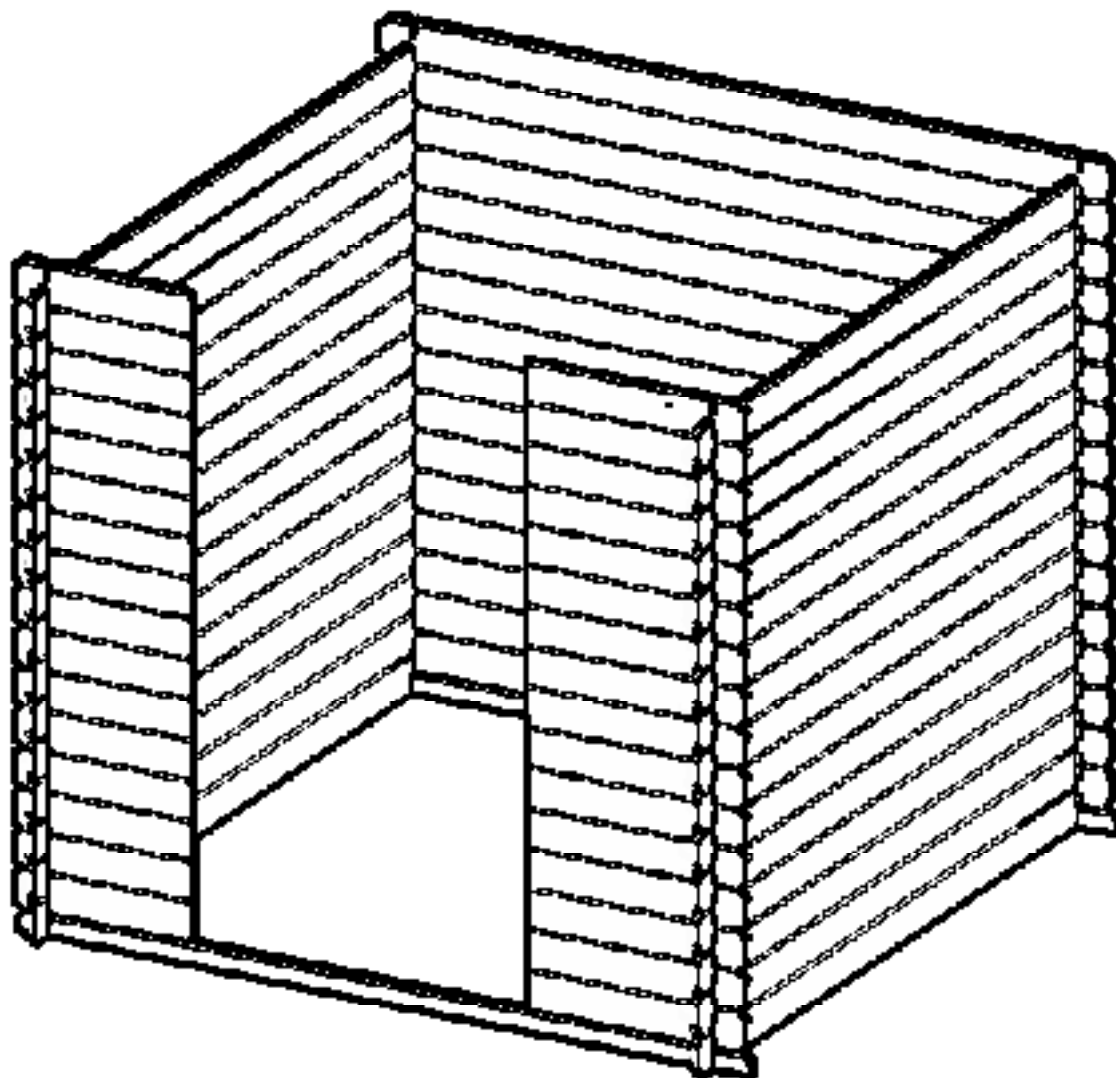

C

N4 = 1pc

N5 = 1pc

NZ1 = 1 + 1 pcs.

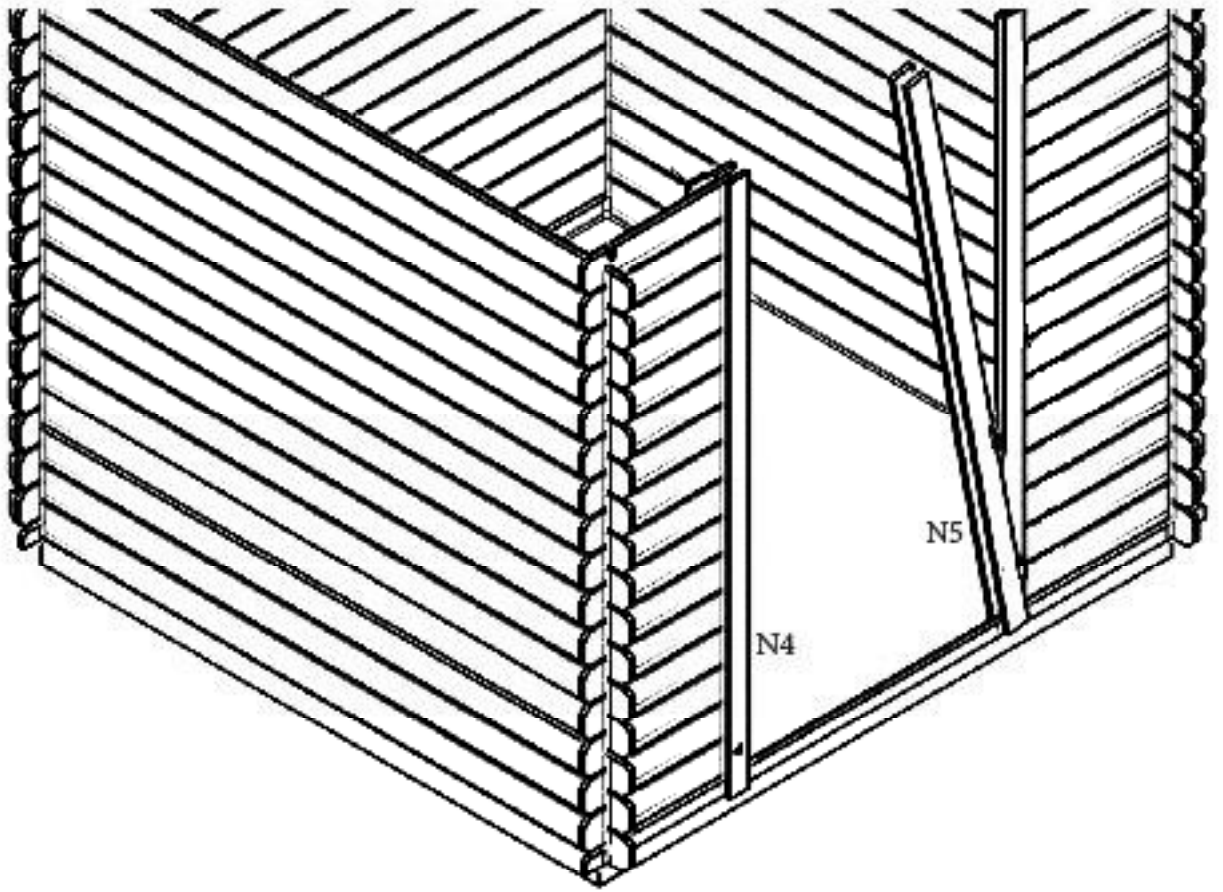

D

N6 = 1pc

N7 = 1 + 1 pcs.

NZ2 = 3 + 3 pcs.

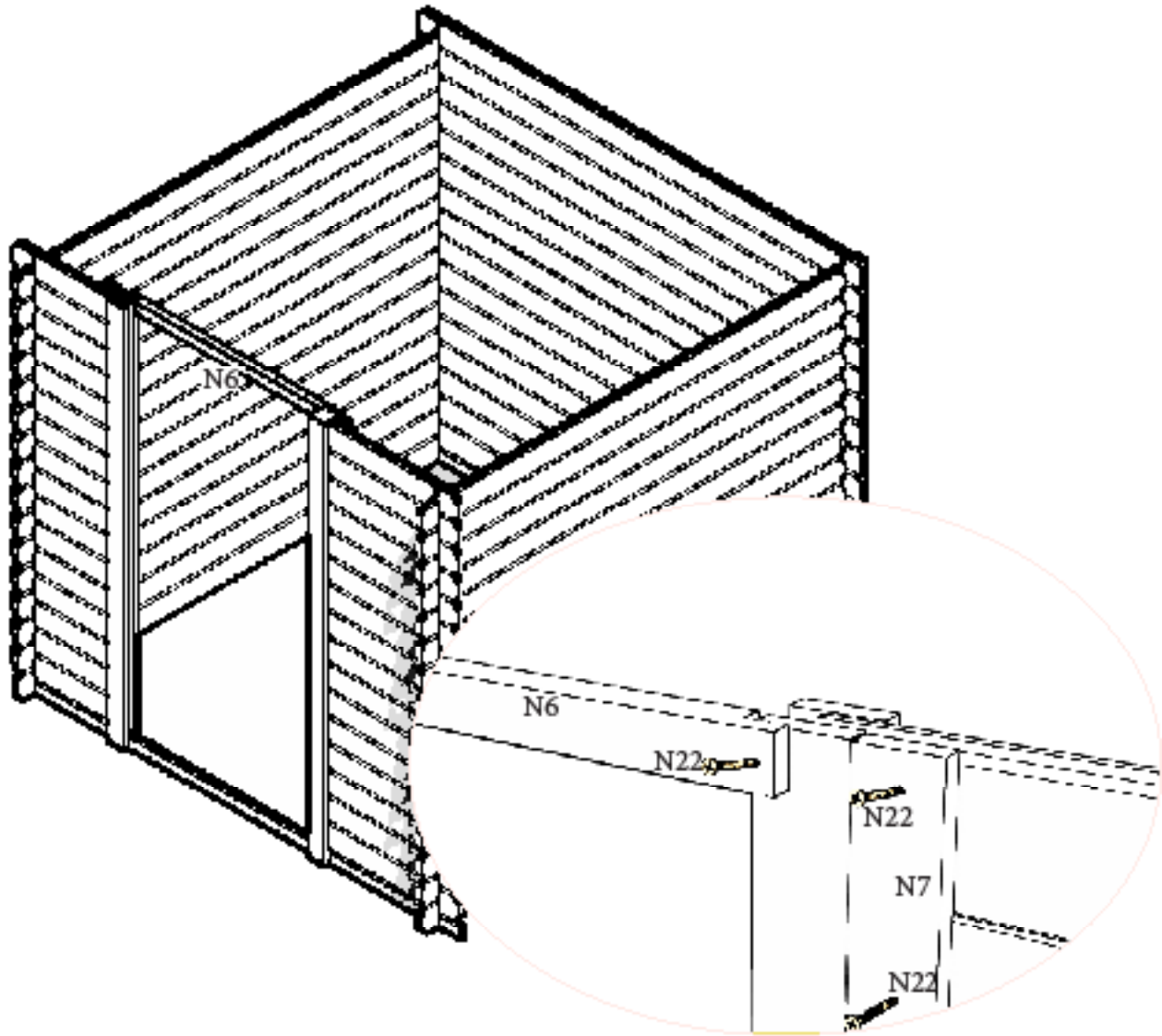

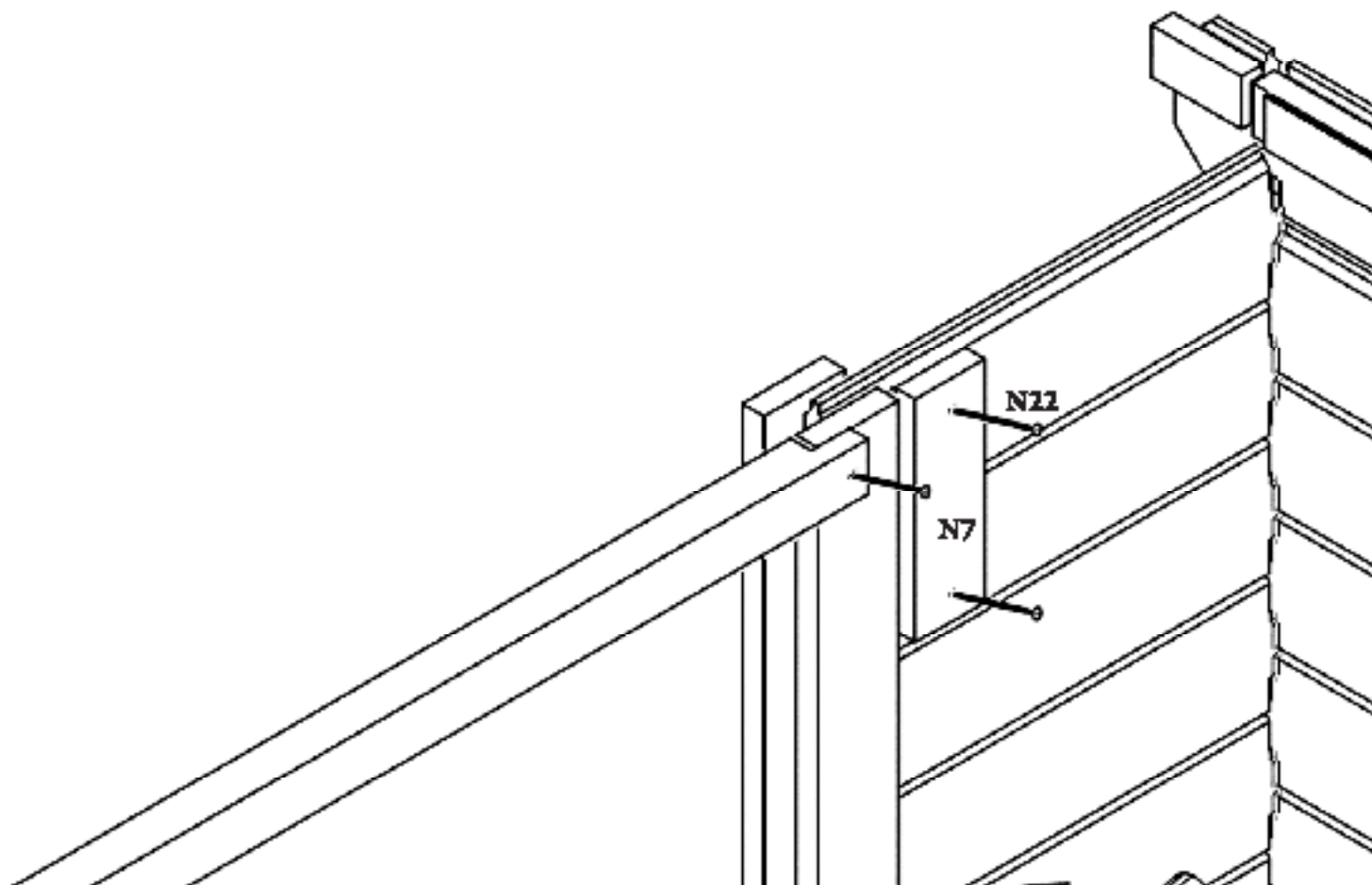

N21 = 1 + 1 pcs.

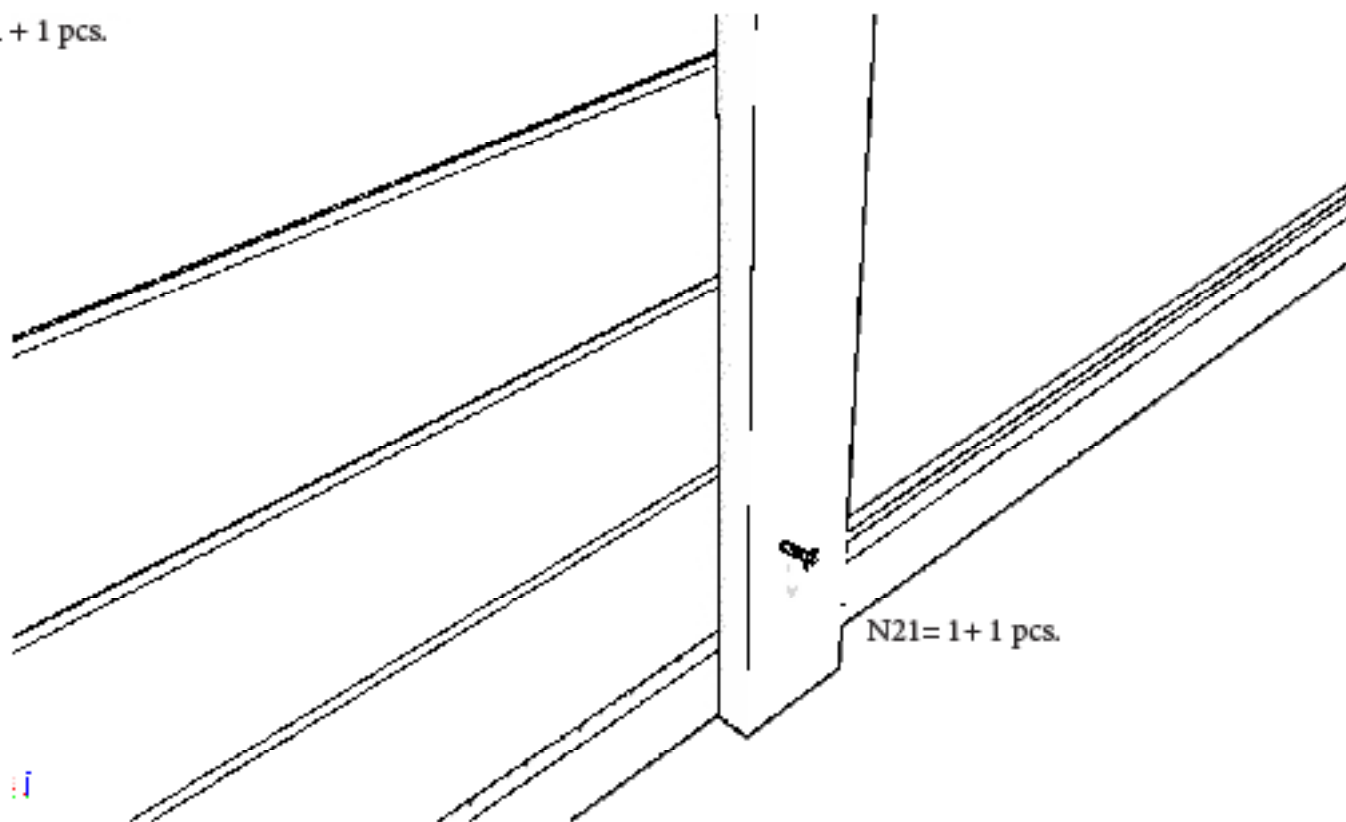

N21 = 1 + 1 pcs.

E

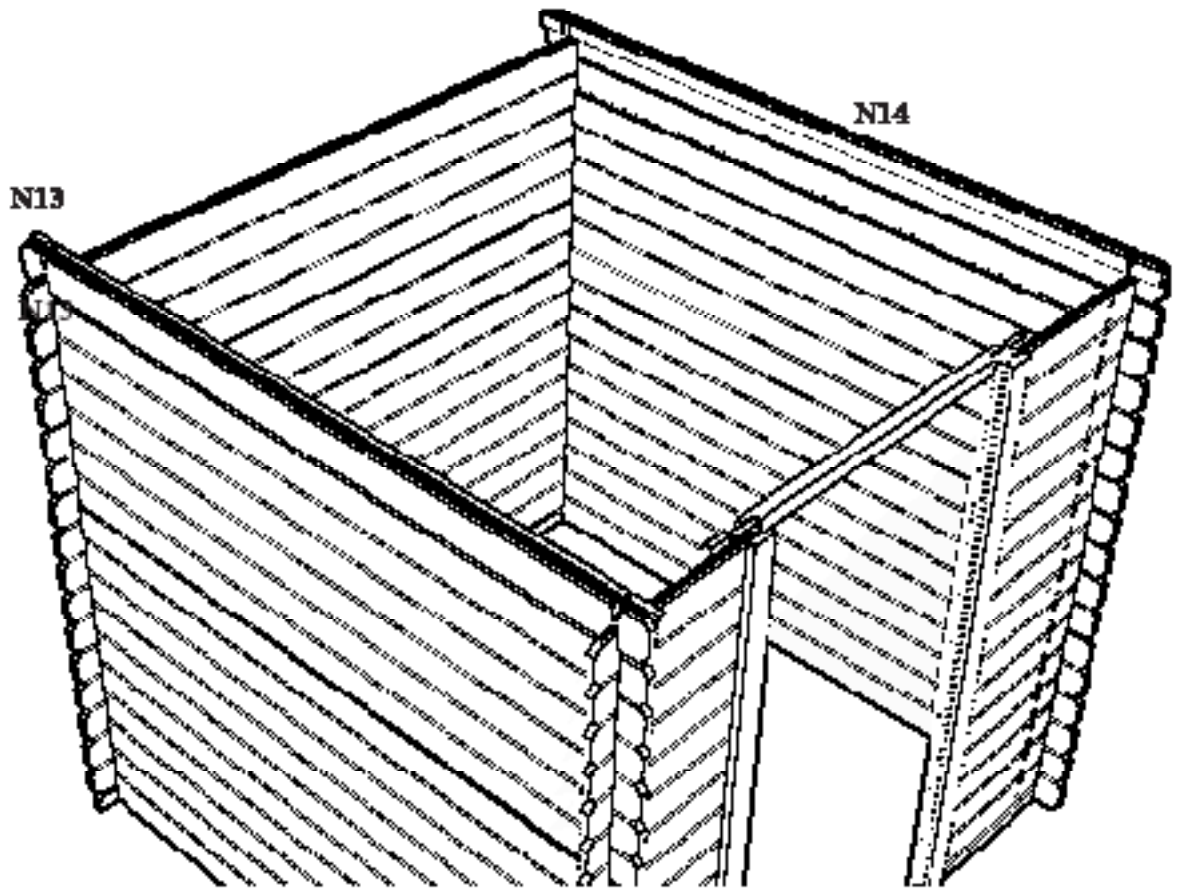

F

N8 = 1 + 1 pcs.

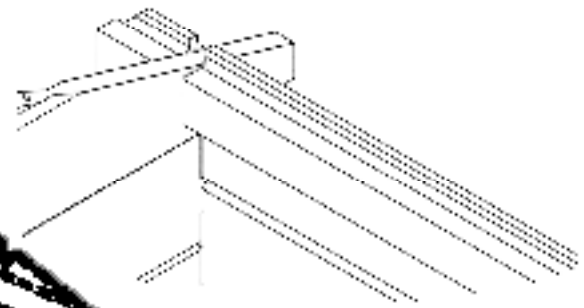
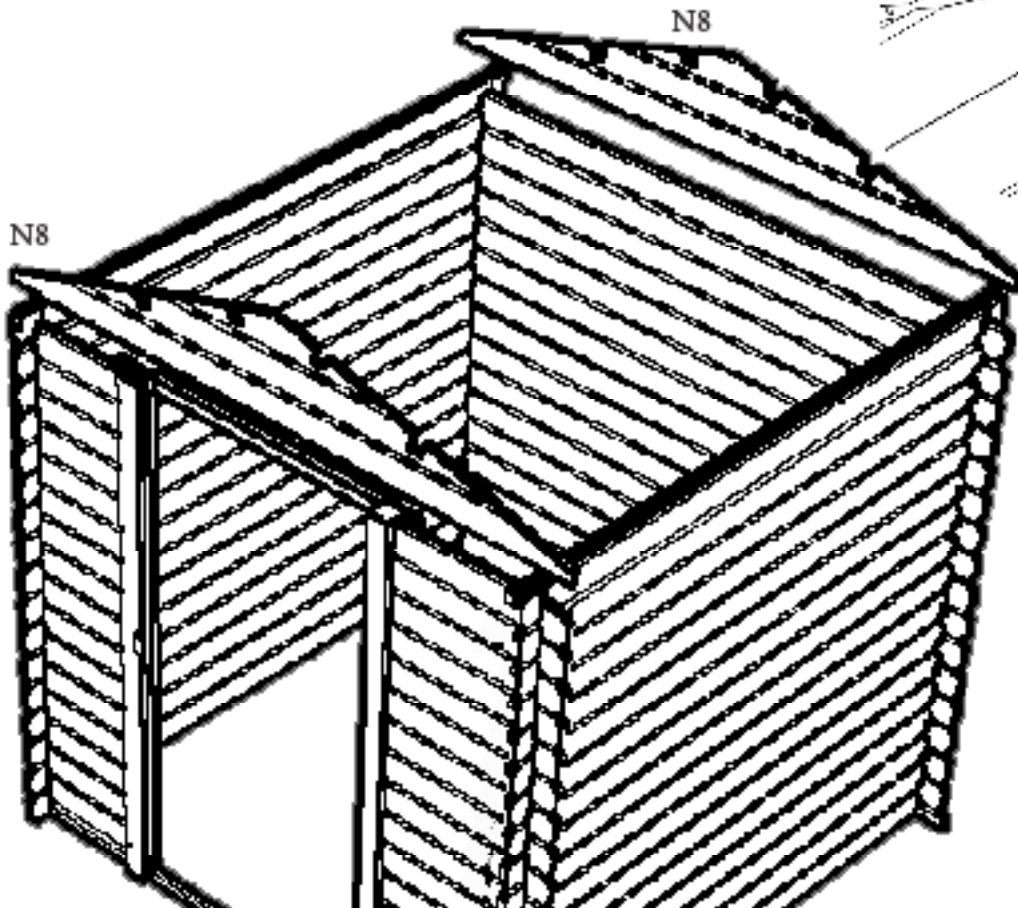

G

N9= 4 pcs.

N23= 8 pcs.

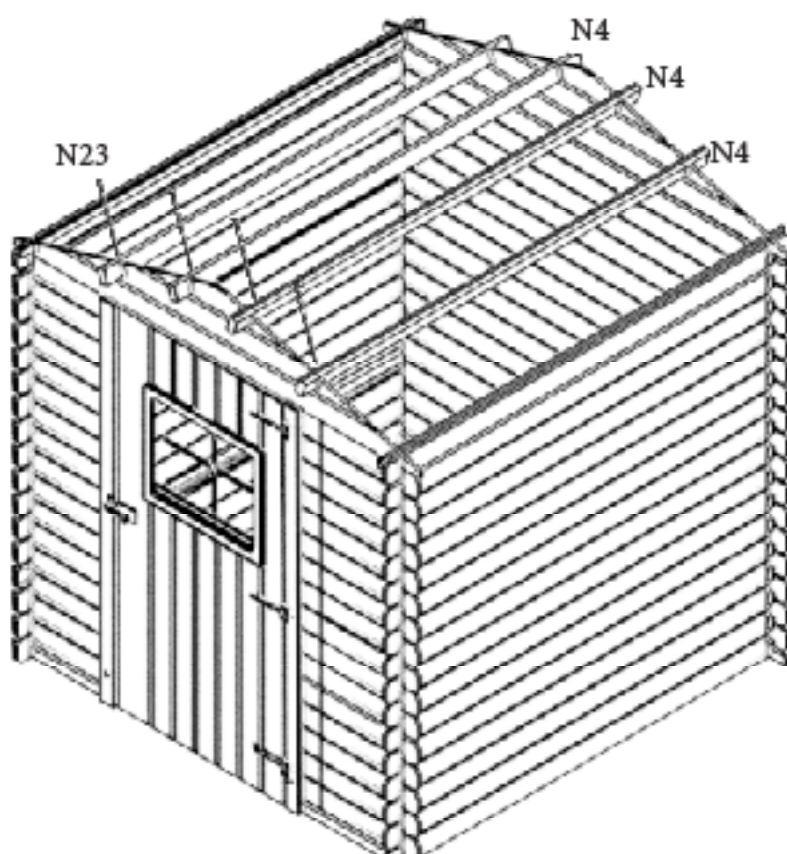

H

N21= 28 pcs.

N11= 2 + 2 pcs.

N12= 1 + 1 pcs.

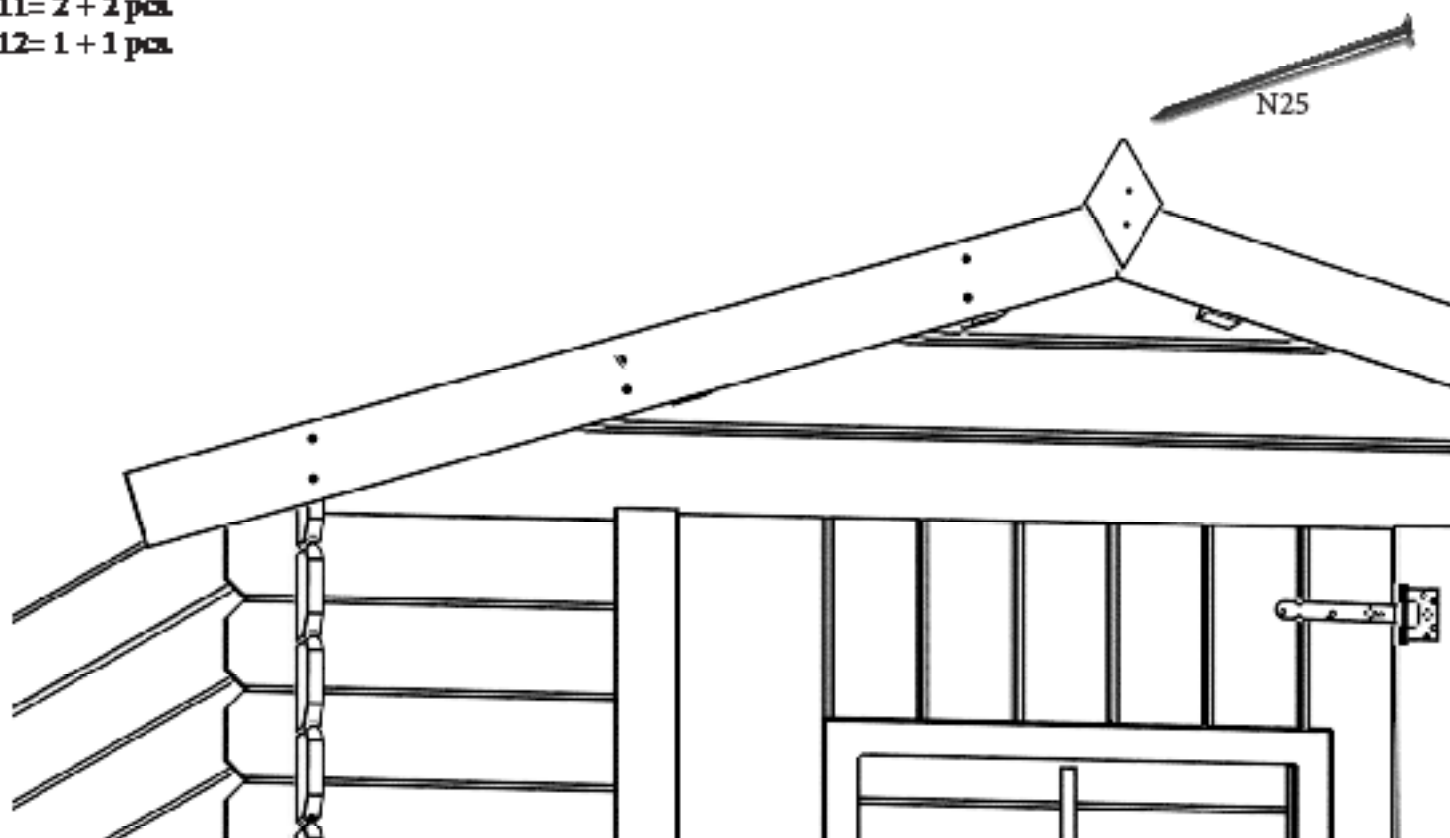

I
N26= 28 pcs.

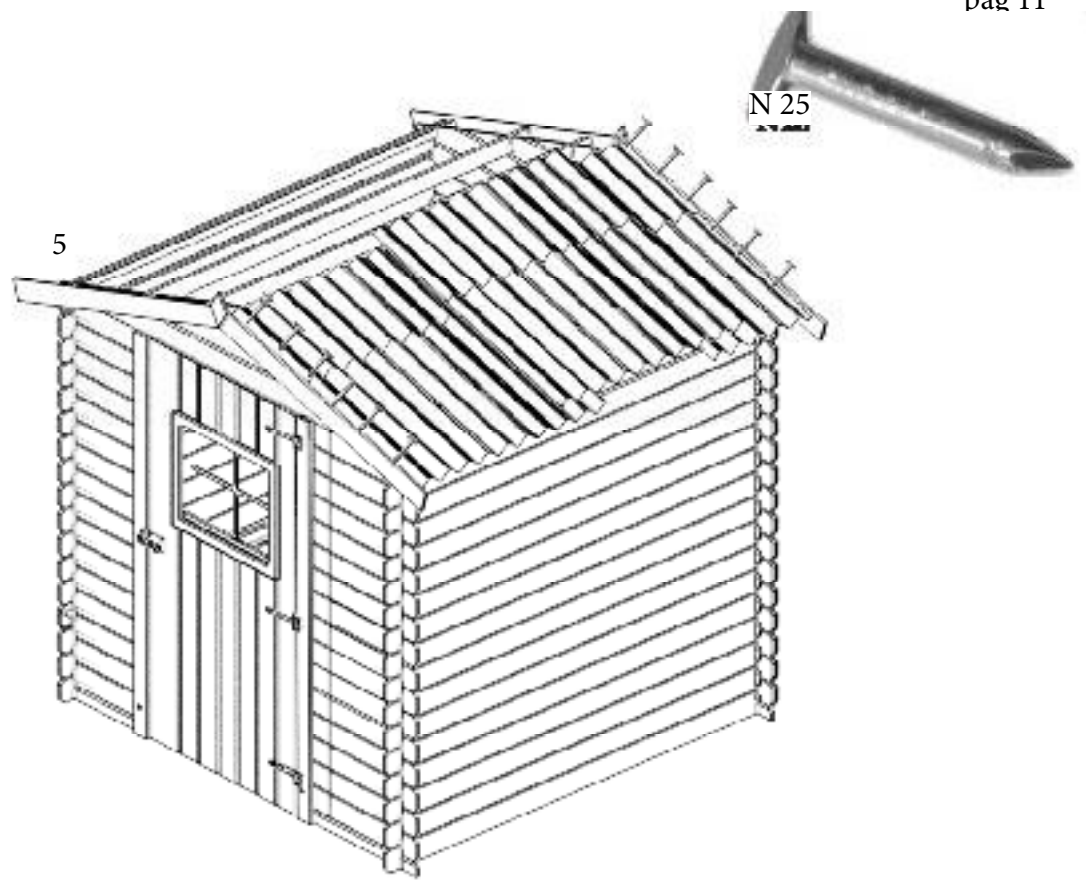

J

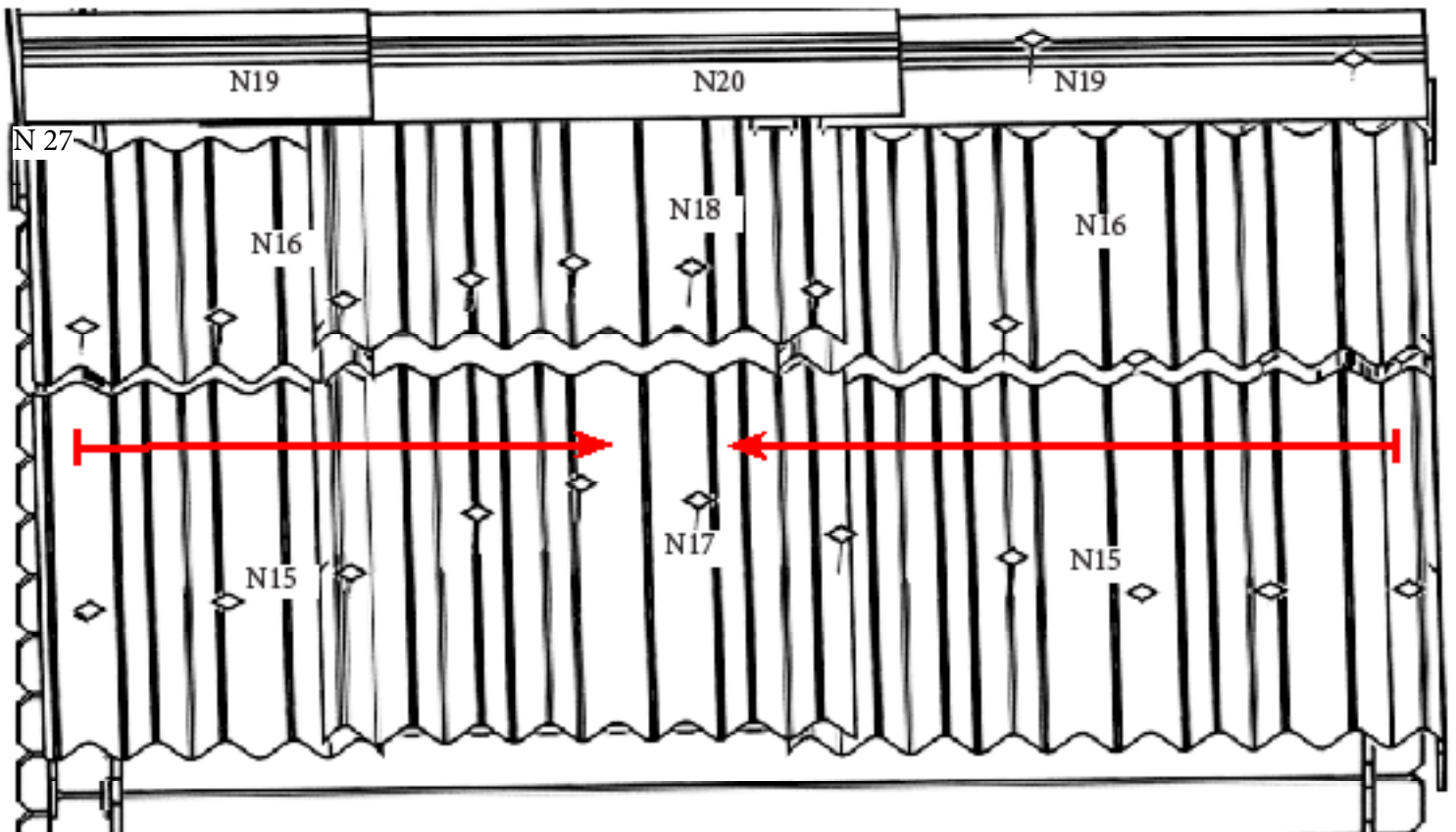

J
N28= 20 pcs.
N19= 2 pcs.
N20= 1 pc.

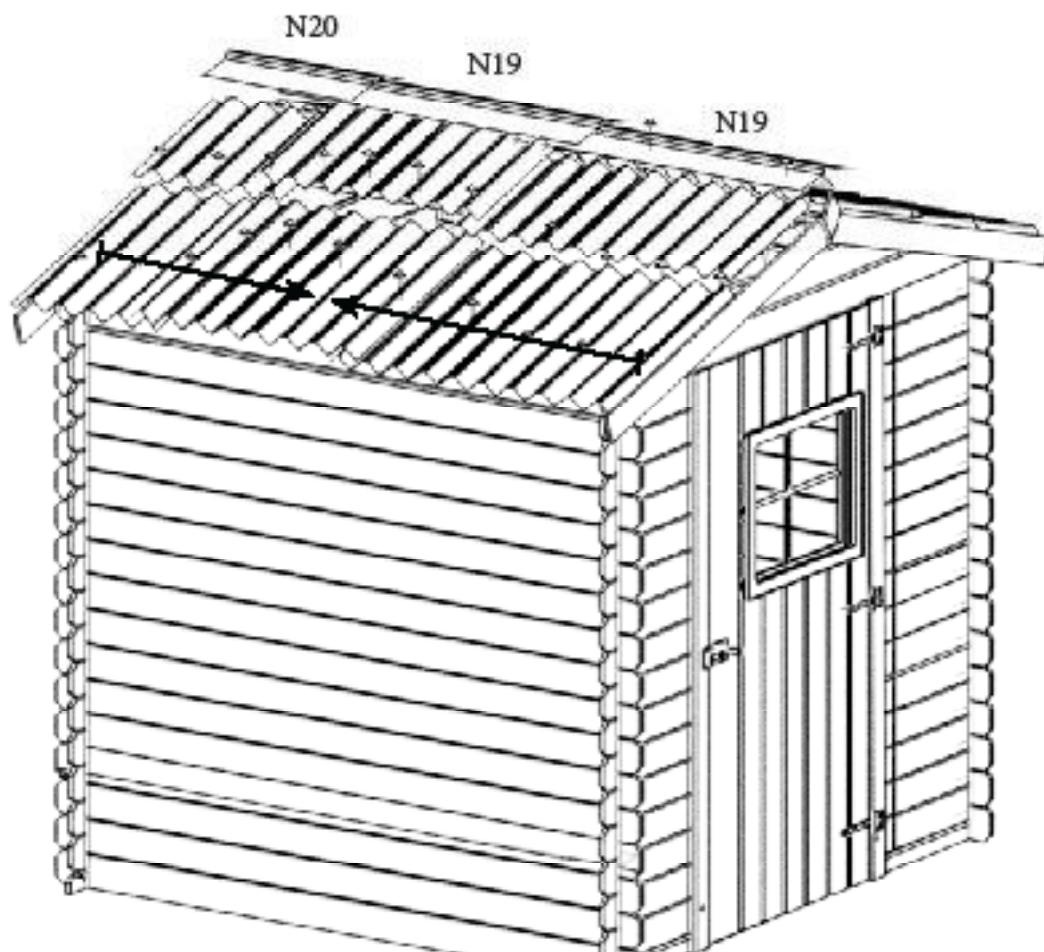

K

N 26
N10= 19 :
N 21 = 6 pcs.
N 22 = 13 pcs

