

NOTICE DE MONTAGE
Istruzioni per l'installazione
Assembly instruction

réf. NAN 5040.02N
ref. NAN 5040.02N
ref. NAN 5040.02N

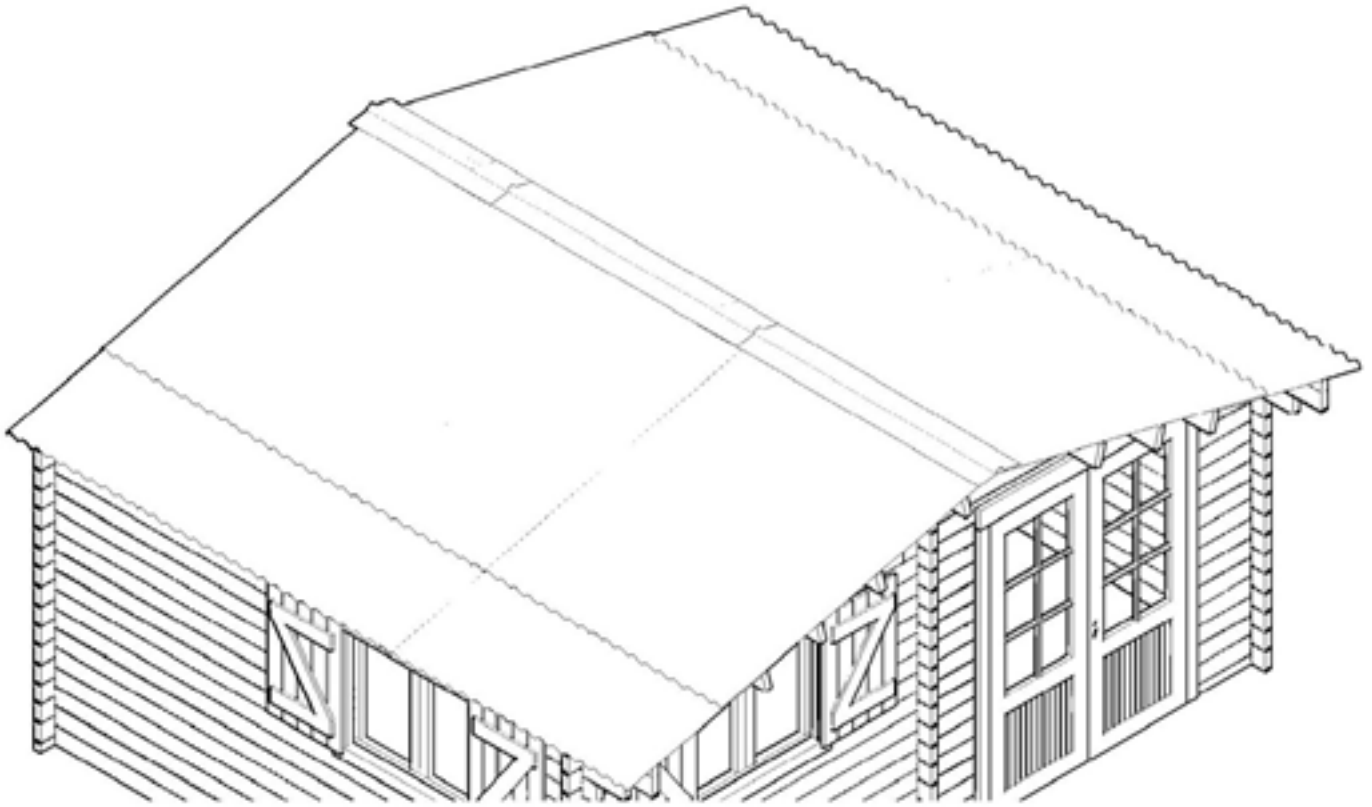

Surf. au sol / Superf. interna netta/ Internal surface : 20 m²

Surf. hors tout / Superficie totale/ Total surface : 22,87 m²

Pente de toit/ Pendenza tetto/ Roof slope : 17 °

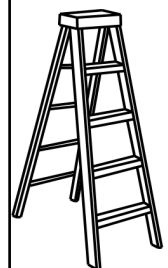
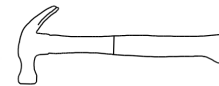

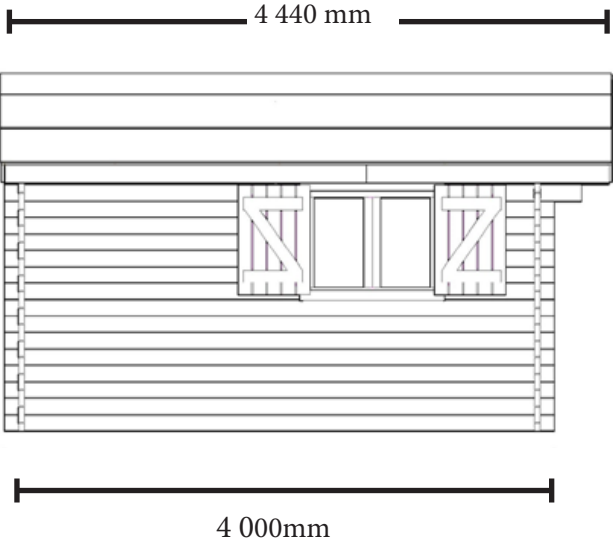
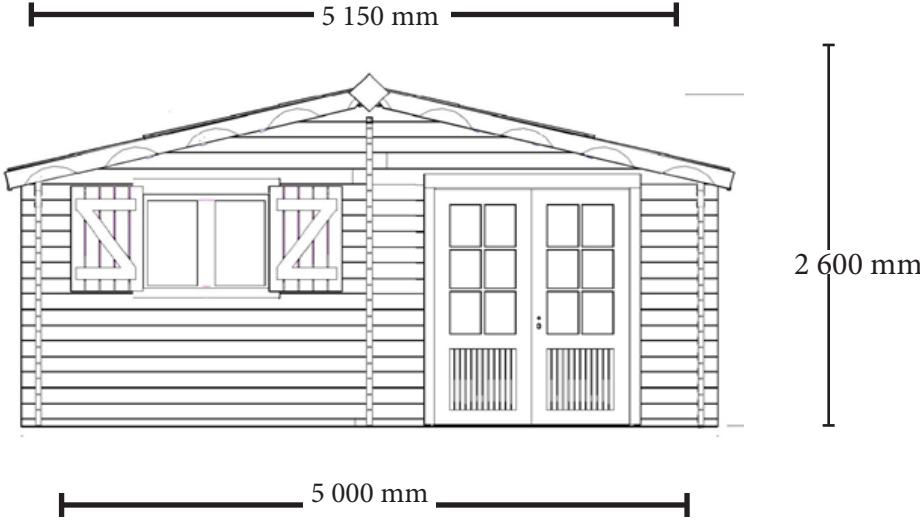

Plan de soubassement NAN 5040.02N
 Piano di basamento NAN 5040.02N
 Basement plan NAN 5040.02N

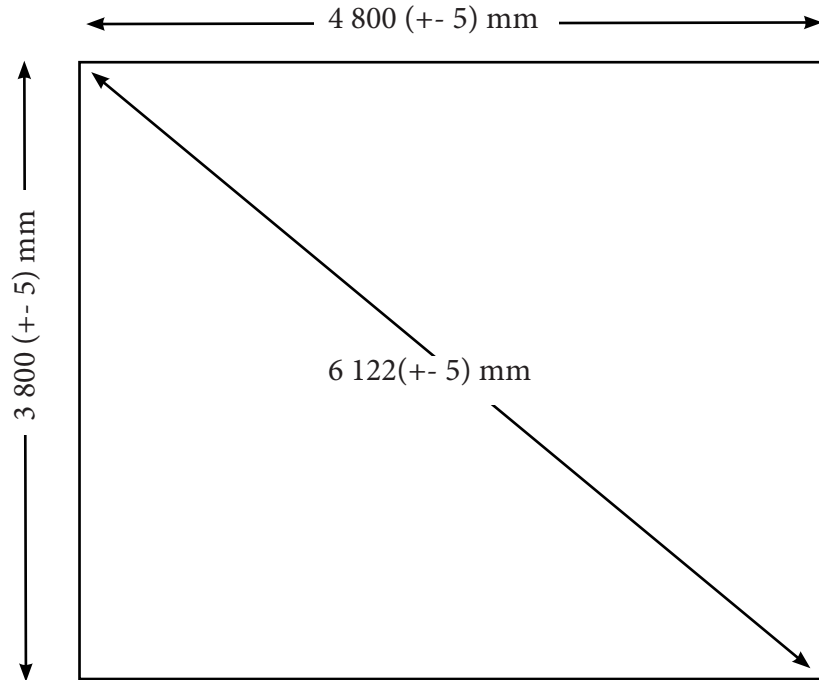





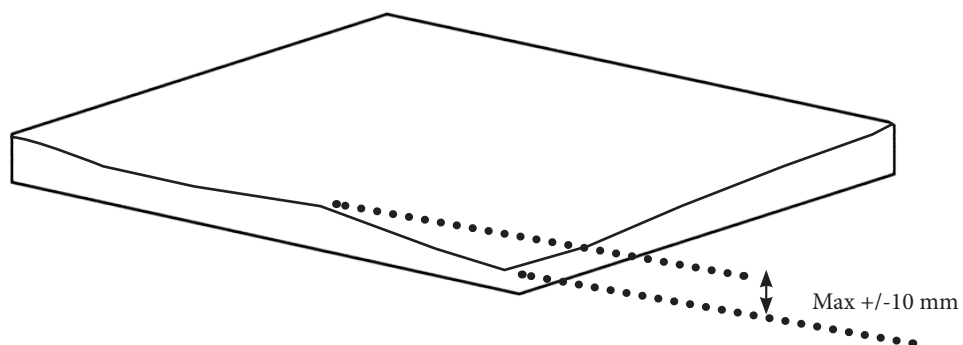



Les dimensions données sur le plan de soubassement sont les dimensions de la dalle béton à réaliser sur un sol parfaitement plat sans aucun autre objet extérieur type mur, clôture ou arbre dans l'entourage de la dalle. Si le produit est implanté près d'un mur, d'une haie ou d'un arbre il est nécessaire de l'éloigner des éléments extérieurs afin de pouvoir facilement le monter et l'entretenir. Nous nous dégageons de toute responsabilité en cas de mauvaise interprétation des dimensions de la dalle.

Le dimensioni del piano di base sono le dimensioni della soletta di cemento da realizzare su un terreno perfettamente piatto, senza alcun altro oggetto esterno, come un muro, una recinzione o un albero in prossimità della soletta. Se il prodotto è installato vicino ad una parete, un recinto o un albero, è necessario distanziarlo adeguatamente, in modo da poterlo facilmente montare e farne la manutenzione. Non ci assumiamo alcuna responsabilità per l'errata interpretazione delle dimensioni della lastra.



1.	I42.2.2622	2622 x 65 x 42	1	
2.	I42.1.2398	2398 x 65 x 42	1	
3.	L42.1.845	845 x 130 x 42	15	
4.	L42.1.845	845 x 130 x 42	7	
5.	L42.2.2665	2665 x 130 x 42	8	
6.	L42.1.830	820 x 130 x 42	7	
7.	L42.1.242	242 x 130 x 42	20	
8.	L42.2.4000	4000 x 130 x 42	14	
9.	LS42.1.2520	2520 x 130 x 42	1	
	LS42.1.1700	1700 x 130 x 42	1	
10.	LSD42.1.1980	1980 x 191 x 42	1	
	LSD42.1.2380	2380 x 191 x 42	1	
11.	L42.2.4000	4000 x 130 x 42	8	
12.	L42.1.845	845 x 130 x 42	6	
13.	L42.1.2155	2155 x 130 x 42	6	
14.	LS42.1.2155	2155 x 130 x 42	1	
	LS42.1.1045	1045 x 130 x 42	1	
15.	LSD42.1.1980	1980 x 191 x 42	1	
	LSD42.1.2380	2380 x 191 x 42	1	
16.	I42.2.2622	2622 x 65 x 42	1	
17.	I42.1.2398	2398 x 65 x 42	1	
18.	L42.2.2622	2622 x 130 x 42	15	
19.	L42.1.2398	2398 x 130 x 42	15	
20.	L42.1.242	242 x 130 x 42	20	
21.	US1800.700	1800 x 700 x 28	1	
	UD1800.700	1800 x 700 x 28	1	
22.	C780.485.42	780 x 485 x 40	2	
23.	LF42.1.2622d	2622 x 130 x 42	1	
	LF42.1.2622	2622 x 130 x 42	1	
	LF42.1.2398	2398 x 130 x 42	2	
	LF42.1.2550	2550 x 130 x 42	2	
	LF42.1.2320	2320 x 130 x 42	2	
	LF42.1.3888	3888 x 130 x 42	2	
	LF42.1.2925	2925 x 130 x 42	2	
	LF42.1.1963	1963 x 130 x 42	2	
	LF42.1.1000	1000 x 130 x 42	2	
24.	FIEB2597.180	2597 x 180 x 40	2	
		3950 x 130 x 20	2	
		1500 x 130 x 20	2	
25a.		2000 x1000 x 30	10	
25b		998 x1000 x 30	10	
26a.		2000 x 330 x 30	2	
26b		1000 x 330 x 30	1	
27.	GL2430.90	2430 x 90 x 40	8	
	GL2030.90	2030 x 90 x 40	8	
28.	DSF2700.90	2700 x 90 x 20	2	
29.	DSF2700.90	2700 x 90 x 20	2	
30.	R200.100	200 x 100 x 20	2	
31.	ERP.2000.90	2000 x 90 x 40	2	
32.	DPV1800.60	1800 x 60 x 16	1	
	QNA5040.02		1	

						Demande sav	
N°	REF	DES.	DIM (mm)	QTE	PLAN	OBS	QTE
33	Vis 4 x 45		4 x 45	32			
34	Clous L100		100	24			
35	Vis 3,0 x 30		3X30	12			
37	Clous L16		1X16	40			
38	Serrure		3.5X35	24			
39	Verrou a douille						
40	Vis 3,5 x 35						
41	Clous8x140 mm		8x140	18			

Demande sav

A compléter impérativement pour toute demande SAV et à envoyer par mail à sav@foresta.fr + photo des pièces abîmées (To be completed imperatively + Photo of damaged parts)

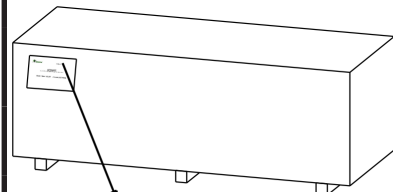

Colis n°: _____

NAN 5040.02N

Colis(package) n° :

MAGASIN (STORE)

NOM (NAME) CLIENT

PRENOM(PRE.)
CLIENT

TEL.

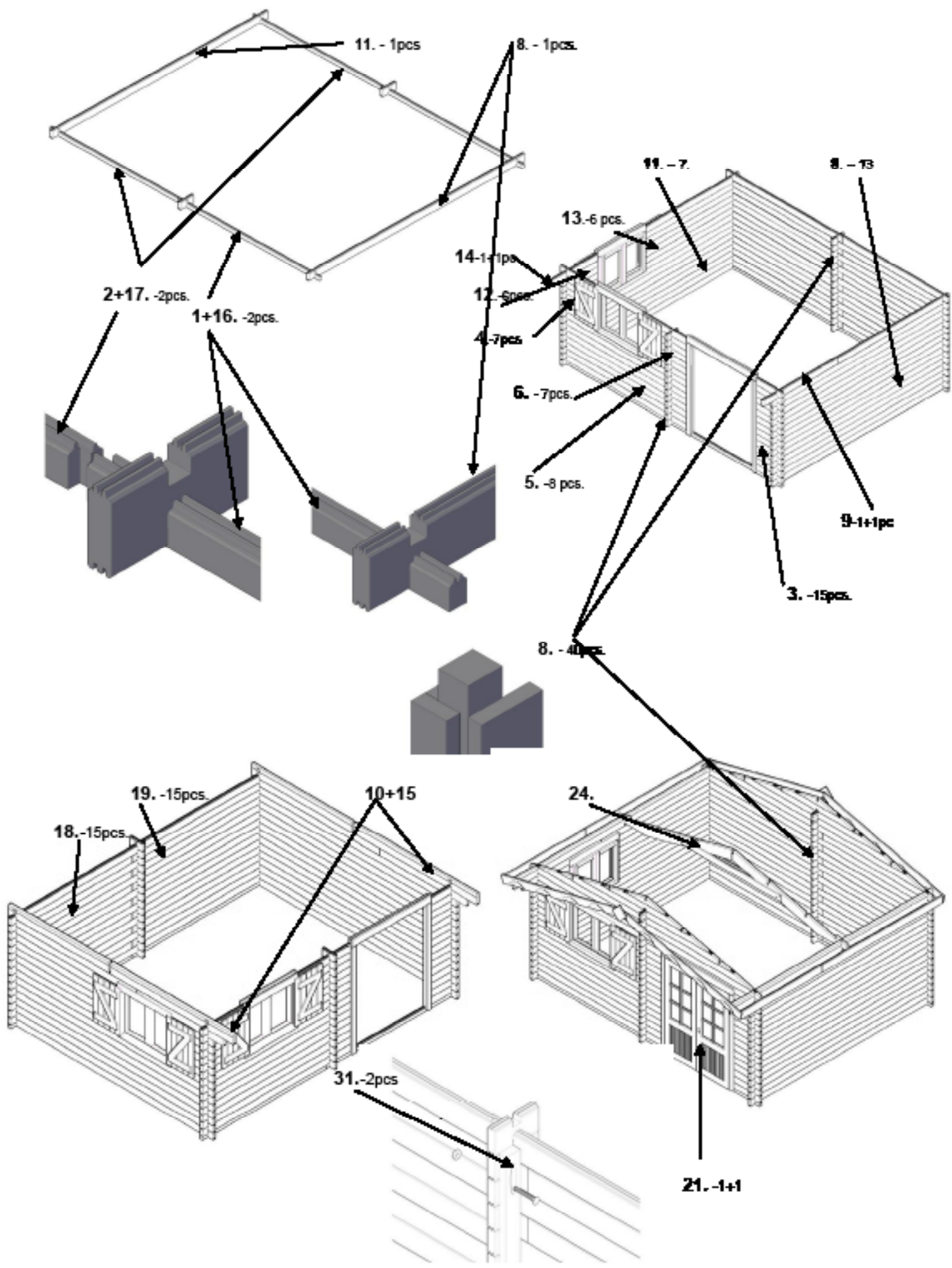

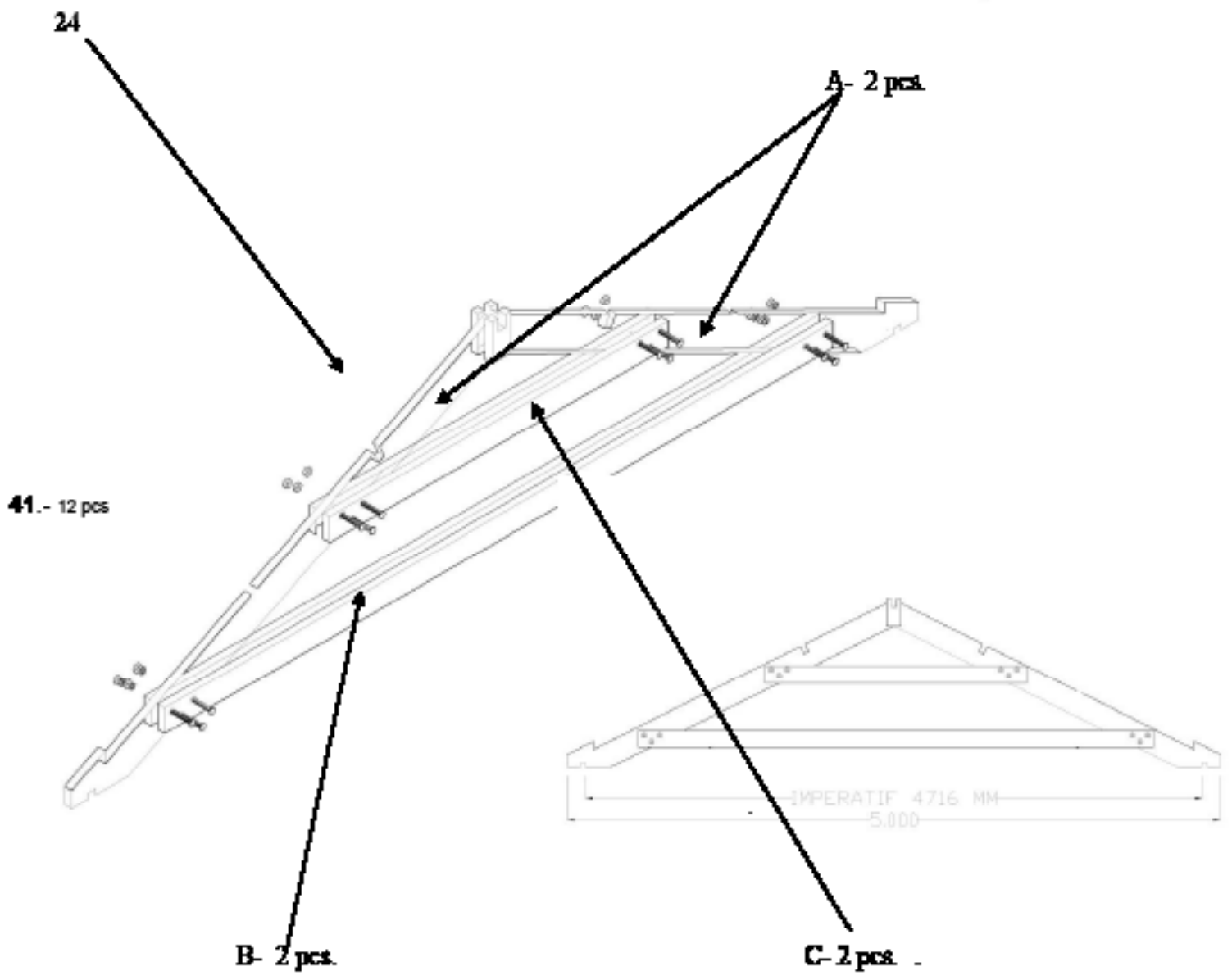
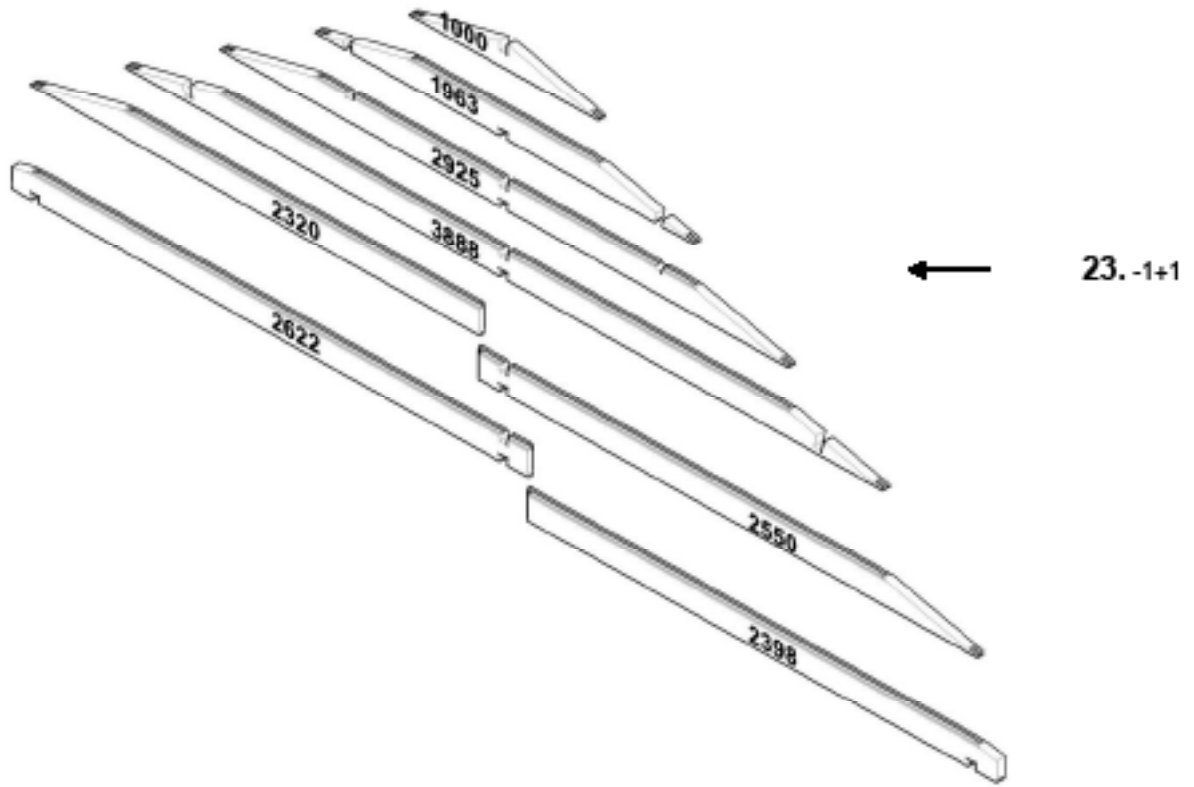

34.- 24pcs

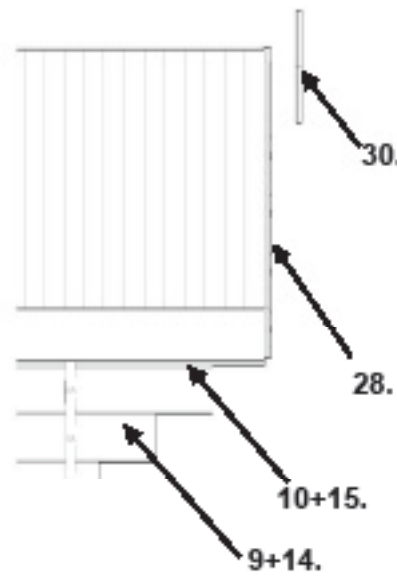
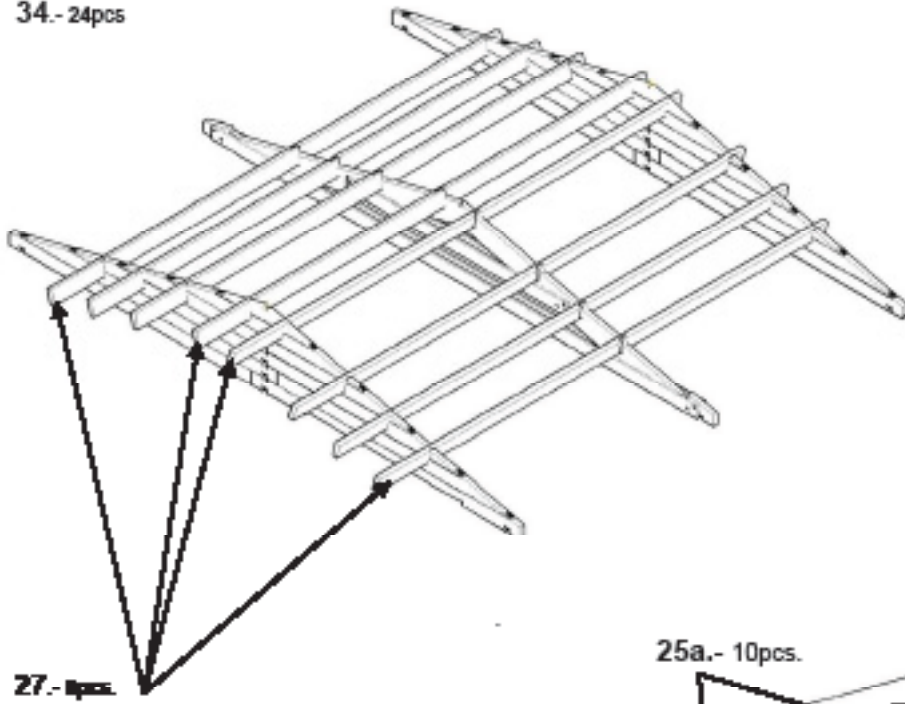

27.- 8pcs

40.- 24pcs

25a.- 10pcs.

25b.- 10pcs.

42.- 300 pcs.

26.- 2+1 pcs

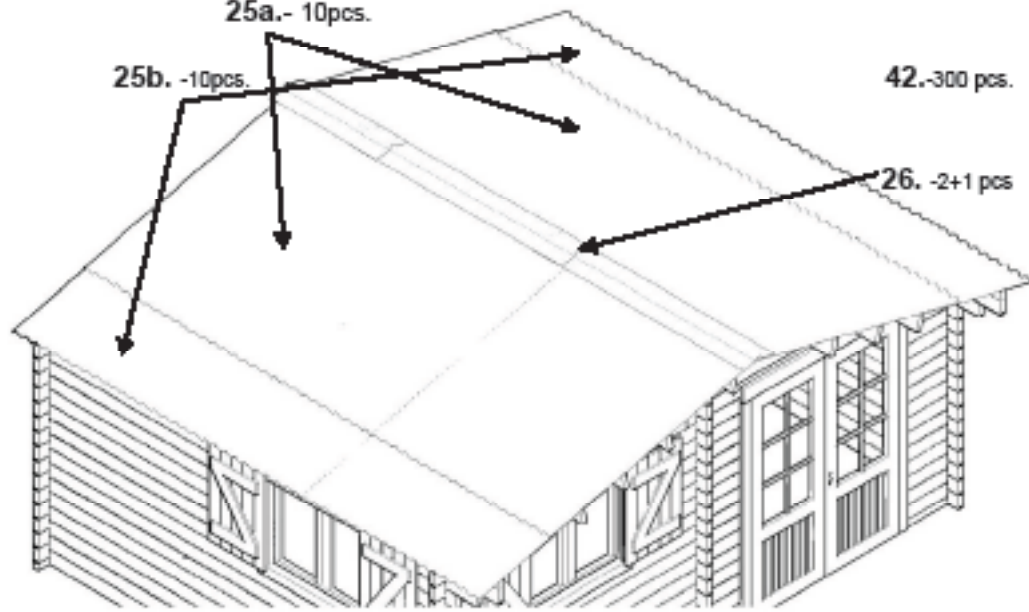
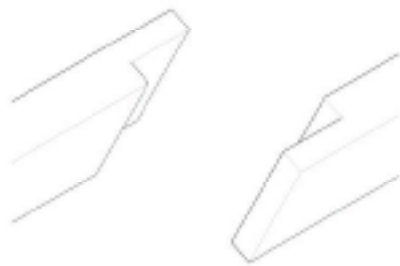

21.- 1+1 pcs.

